

# **SymNet™** | Network Audio Solutions

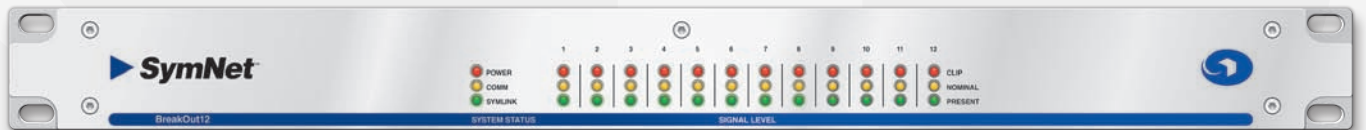

## Quick Start Guide

### BreakIn12 BreakOut12

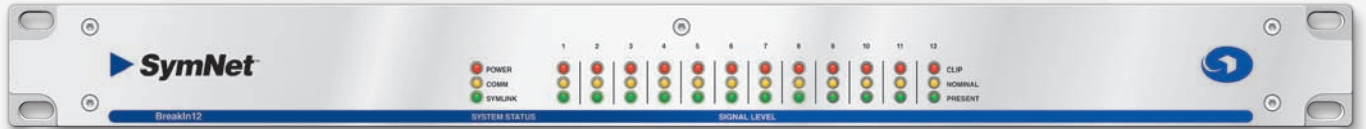

## Before You Begin

### What Ships in the Box

- A BreakIn12 or BreakOut12 hardware device.
- SymNet Designer CD-ROM (Windows).
- A SymLink patch cable.
- A ferrite clamp.
- A detachable power cord.
- This Quick Start Guide.

### What You Need to Provide

- A Windows® PC with 300MHz or higher Pentium® and:
  - + WIN 98SE, ME, 2000 or XP®.
  - + 10-15 MB free storage space.
  - + 1024x768 graphics capability.
  - + 16-bit or higher colors.
  - + CD-ROM drive or Internet connection.
  - + 64MB RAM (WIN 98SE/ME), 128MB RAM (WIN 2000/XP).
- A SymNet DSP or CobraLink hardware device, the BreakI/O hardware devices can not be used stand-alone.

### Getting Help

SymNet Designer, the Windows application that controls all SymNet hardware, includes a help module which acts as a complete User's Guide for both hardware (including the BreakIn12 and BreakOut12 devices) and software.

If you have questions beyond the scope of the help module, contact our Customer Support Group in the following ways:

**Tel:** +1 (425) 778-7728  
8:00 am to 4:30 pm  
Monday through Friday,  
Pacific Time

**Web:** <http://www.SymetrixAudio.com>

This device complies with part 15 of the FCC Rules. Operation is subject to the following two conditions: (1) This device may not cause harmful interference, and (2) this device must accept any interference received, including interference that may cause undesired operation.



This Class B Digital apparatus meets all requirements of the Canadian Interference-Causing Equipment Regulations  
Cet appareil numérique de la classe B respecte toutes les Exigences du Règlement sur le matériel brouilleur du Canada.

Keep up-to-date with the latest version of SymNet Designer™, the Windows® application that controls all SymNet hardware, go to: <http://www.SymetrixAudio.com>

### Important Safety Instructions.

- 1 Read these instructions.
- 2 Keep these instructions.
- 3 Heed all warnings.
- 4 Follow all instructions.
- 5 Do not use this apparatus near water. This apparatus shall not be exposed to dripping or splashing and no objects filled with liquids, such as vases, shall be placed on the apparatus.
- 6 Clean only with dry cloth.
- 7 Do not block any ventilation openings. Install only in accordance with the manufacturer's instructions.
- 8 Do not install near any heat sources such as radiators, heat registers, stoves, or other apparatus (including amplifiers) that produce heat.
- 9 This apparatus shall be connected to a mains socket outlet with a protective earthing connection. Do not defeat the safety purpose of the polarized or grounding-type plug. A polarized plug has two blades with one wider than the other. A grounding type plug has two blades and a third grounding prong. The wide blade or the third prong are provided for your safety. If the provided plug does not fit into your outlet, consult an electrician for replacement of the obsolete outlet.
- 10 Protect the power cord from being walked on or pinched particularly at plugs, convenience receptacles, and the point where they exit from the apparatus.
- 11 Only use attachments/accessories specified by the manufacturer.
- 12 Use only with the cart, stand, tripod, bracket, or table specified by the manufacturer, or sold with the apparatus. When a cart is used, use caution when moving the cart/apparatus combination to avoid injury from tip-over.
- 13 Unplug this apparatus during lightning storms or when unused for long periods of time.
- 14 Refer all servicing to qualified service personnel. Servicing is required when the apparatus has been damaged in any way, such as power-supply cord or plug cord is damaged, liquid has been spilled or objects have fallen into the apparatus, the apparatus has been exposed to rain or moisture, does not operate normally, or has been dropped.



	<b>CAUTION</b> RISK OF ELECTRIC SHOCK DO NOT OPEN	
<b>WARNING:</b> TO REDUCE THE RISK OF FIRE OR ELECTRIC SHOCK DO NOT EXPOSE THIS EQUIPMENT TO RAIN OR MOISTURE		
<b>AVIS:</b> RISQUE DE CHOC ELECTRIQUE NE PAS OUVRIR		

SEE OWNERS MANUAL. VOIR CAHIER D'INSTRUCTIONS.  
No user serviceable parts inside. Refer servicing to qualified service personnel.  
Il ne se trouve a l'interieur aucune piece pouvant etre repareré l'usager.  
S'adresser a un reparateur competent.

- ! **The lightning flash** with arrowhead symbol within an equilateral triangle is intended to alert the user of the presence of uninsulated "dangerous voltage" within the product's enclosure that may be of sufficient magnitude to constitute a risk of electric shock to persons. The exclamation point within an equilateral triangle is intended to alert the user of the presence of important operating and maintenance (servicing) instructions in the literature accompanying the product (i.e. this Quick Start Guide).
- ! **CAUTION:** To prevent electric shock, do not use the polarized plug supplied with the unit with any extension cord, receptacle, or other outlet unless the prongs can be fully inserted.
- ! **Power Source:** This Symetrix hardware uses a switching power supply that automatically adjusts to the applied voltage. Ensure that your AC mains voltage is somewhere between 100-240 VAC, 50-60 Hz. Use only the power cord and connector specified for the product and your operating locale. A protective ground connection, by way of the grounding conductor in the power cord, is essential for safe operation. The appliance inlet and coupler shall remain readily operable once the apparatus has been installed.
- ! **User Serviceable Parts:** There are no user serviceable parts inside this Symetrix product. In case of failure, customers inside the U.S. should refer all servicing to the Symetrix factory. Customers outside the U.S. should refer all servicing to an authorized Symetrix distributor. Distributor contact information is available online at: <http://www.SymetrixAudio.com>.

Warning

# ! WARNING! !

The RJ-45 connectors labeled “ARC” are only for use with the ARC series of remotes.

**DO NOT plug the ARC connectors on Symetrix products into any RJ-45 connector labeled “SYMLINK”, “ETHERNET” or “COBRANET”.**

The “ARC” RJ-45 connectors on Symetrix products can carry anywhere from 6 to 24 VDC which can damage SymLink, Ethernet and CobraNet circuitry.

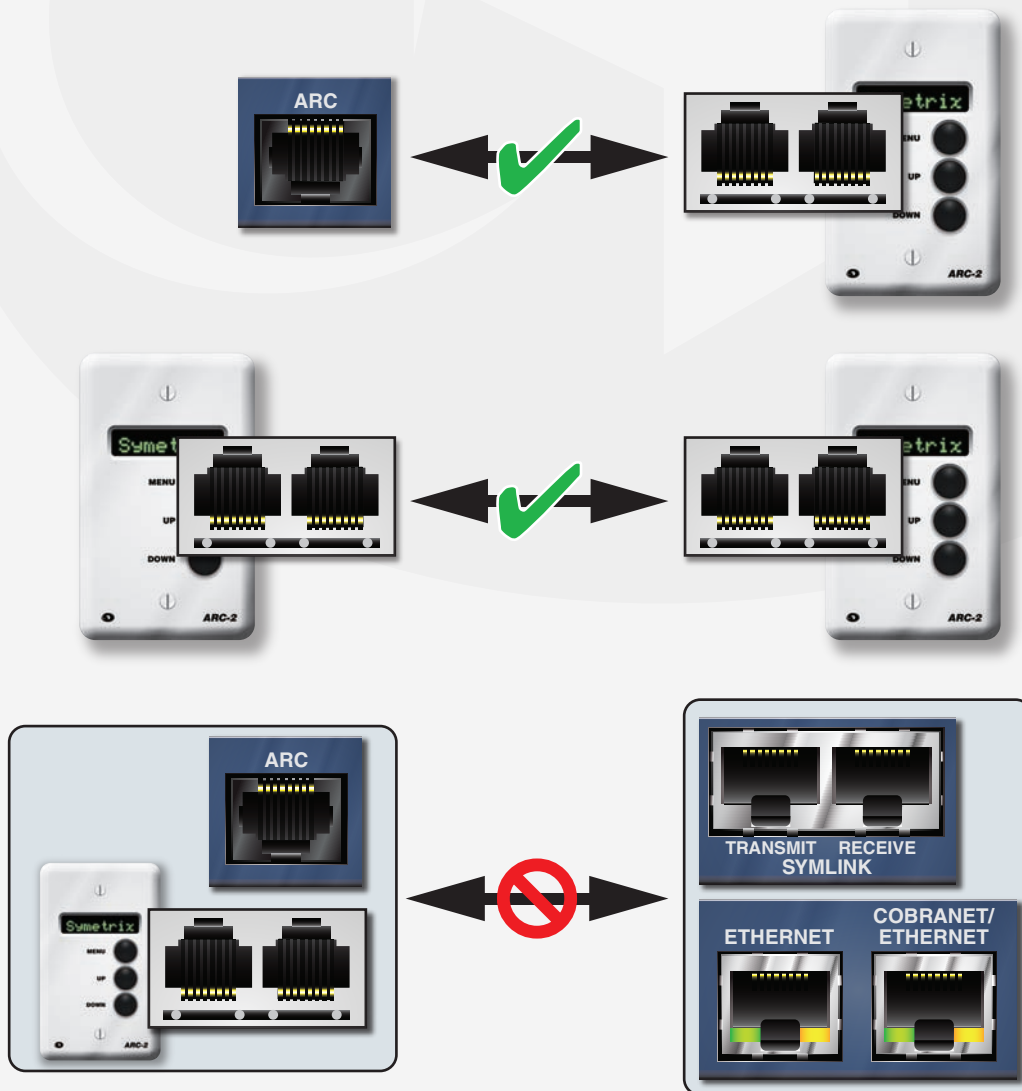

## Introduction

SymNet™ is a scalable DSP platform configured by SymNet Designer software and made by Symetrix. Installed in Convention Centers, Sports Arenas, Houses of Worship and many other venues throughout the world, consultants, integrators and end-users rely on the robust stability of the SymNet platform.

SymNet is an open architecture system. This means DSP modules (EQ, compression, etc.) are placed into the design and connected using standard drag-and-drop methods. Various SymNet hardware can be chained together to provide a custom audio solution for the client. SymNet’s main advantage can be summed up in one word: “Options”. Options for DSP processing, options for audio routing and options for control.

## Overview

The SymNet BreakIn12 and BreakOut12 are one rack space SymNet hardware devices which feature twelve selectable mic/line inputs (BreakIn12) or twelve line outputs (BreakOut12) to provide additional analog audio I/O to a SymNet system and are fully setup from the familiar SymNet Designer software. When added to SymNet systems, they can drastically reduce total system price while greatly increasing input and output capacity.

Unlike the SymNet 8x8, DSP unit, the BreakIn12 and BreakOut12 contain no DSP processors, a design feature which accounts for significant cost savings. Because of the tremendous DSP power contained in a single SymNet 8x8 (4 SHARC™ floating point processors), many designs don’t fully utilize the 8x8’s DSP potential. The BreakI/O boxes allow you to tap that full potential. For example, by connecting a BreakIn12 and BreakOut12 to a SymNet 8x8, you create a very powerful 20x20 DSP matrix at an extremely competitive price.

PERFORMANCE DATA BreakIn12	
Item	Specifications
Converter Types	24-bit Sigma Delta
Sampling Rate	48 kHz, +/- 100 ppm
Frequency Response	+/- 0.5 dB, 20 Hz - 20 kHz
A/D dynamic range	> 111 dB (A-weighted)
Total THD+Noise	< 0.003% @ 1 kHz, -1 dBFS
Input impedance	6.67k Ohms, Balanced
Maximum input level	+22 dBu without pad (typical)
Mic pre-amp EIN	-128 dBu, typical from 22 Hz - 22 kHz, A-weighted
Phantom power	+48 VDC, 10 mA (per input)
Input CMR	> 70 dB @ 60 Hz
Channel separation	> 110 dB, in through out @ 1 kHz

PERFORMANCE DATA BreakOut12	
Item	Specifications
Converter Types	24-bit Sigma Delta
Sampling Rate	48 kHz, +/- 100 ppm
Frequency Response	+/- 0.5 dB, 20 Hz - 20 kHz
D/A dynamic range	> 110 dB (A-weighted)
Total THD+Noise	< 0.003% @ 1 kHz, -1 dBFS
Output impedance	210 Ohms, Balanced
Maximum output level	+24 dBu, 100k Ohms (typical)
Channel separation	> 100 dB, in through out @ 1 kHz

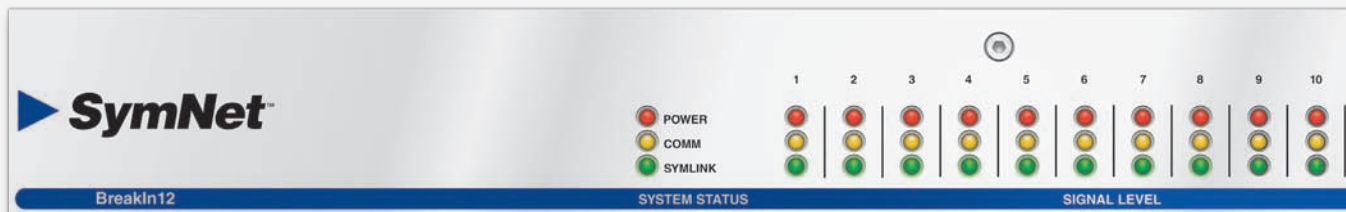

Mechanical Data		
Item	Specifications	Remarks
SPACE REQUIRED	1U (WDH: 48.3 cm x 26.7 cm x 4.37 cm / 19 in x 10.5 in x 1.72 in). Depth does not include connector allowance.	Allow at least 1 inch additional clearance for rear panel connections. Additional depth may be required depending upon your specific wiring and connections.
ELECTRICAL	100 to 240 VAC, 50-60 Hz, 75 watts maximum.	No line voltage switching required.
VENTILATION	Maximum recommended ambient operating temperature is 30 C / 86 F.	Fan on equipment right pulls hot air out of unit. Air intake at equipment left. Ensure that the left and right equipment sides are unobstructed (5.08 cm, 2 in minimum clearance). The ventilation should not be impeded by covering the ventilation openings with items such as newspapers, tablecloths, curtains, etc.
WEIGHT	3.0 kg (6.6 lbs.)	

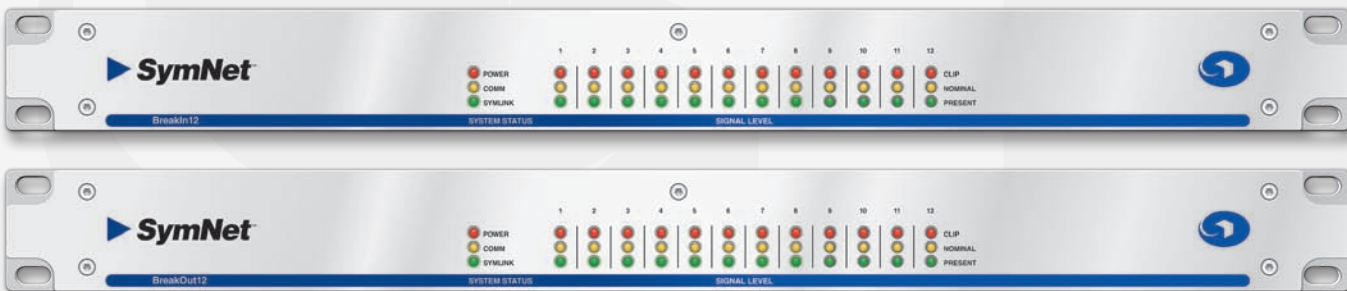

Front Panel		
Item	Description	Remarks
POWER	Red LED	Indicates that the device is powered on. LED is lit solid when operating normally. <b>Note:</b> The LED will flash the number of times equivalent to its SYMLINK ADDRESS upon power up.
COMM	Yellow LED	Indicates current host communications.
SYMLINK ACTIVE	Green LED	Indicates a valid SYMLINK connection. The LED should be lit solid when there is a valid SymLink connection. If flashing or off, check connections, cables and DIP switches.
I/O SIGNAL LEVEL	Red, Yellow, and Green LEDs	Indicates input or output signal level.



Rear Panel		
Item	Description	Remarks
POWER INPUT	IEC 3 prong jack	Accepts power from detachable IEC power cable (100-240 VAC, 50-60 Hz, 75 Watts max).
RS-232	Female DB9	This connection is for factory use only. All communications with the BreakIn12 or BreakOut12 is via the SymLink bus under the control of a SymNet DSP or CobraLink master unit.
SYMLINK TRANSMIT/RECEIVE	RJ-45	Low-latency 64-channel audio and data bus. Use shielded CAT5 cables less than 10 meters in length, standard straight-through wiring.
DEVICE CONFIG	8 DIP switch block	Configures the SymLink Master/Slave status and SymLink device address.
ANALOG INPUTS (BreakIn12)	3 pin Euroblocks	12 analog mic / line level audio inputs with individually software-selectable phantom power and level of -50 dBu, -40 dBu, -20 dBu, -10 dBV or +4 dBu.
ANALOG OUTPUTS (BreakOut12)	3 pin Euroblocks	12 analog line level audio outputs with individually software-selectable level of -10 dBV or +4 dBu.

**NOTE:** Detachable Euroblock connectors are designed for use with bare wire. Do not tin stranded wires before inserting them into the connectors.

## SymNet System Connections

### SymLink Connection

The BreakIn12 and BreakOut12 connect to the rest of the SymNet system with SymLink. SymLink is a ring network, unlike Ethernet which uses a hub and spoke topology making a single connection to each device from a hub. Each SymNet hardware device on a SymLink ring has two connections: TRANSMIT and RECEIVE. TRANSMIT connects to the RECEIVE port on the next device in the ring. TRANSMIT from the last device in the ring connects to the RECEIVE port on the first device in the ring. This completes the “SymLink Ring”. When the ring is complete and all connections and device addresses are valid, the SYMLINK ACTIVE LEDs on the fronts of all units will be lit solid green. If any unit’s SYMLINK ACTIVE LED is flashing or unlit, it means that the unit is not receiving a valid SymLink connection from the upstream unit. Check the connection, cabling and DIP switches.

**Note:** Shielded CAT5 cables are recommended for SymLink connections and length must be limited to 10 meters each. One shielded SymLink patch cable is included with each hardware device featuring SymLink connections. Included in the SymNet packaging is a ferrite clamp. In order to maintain CE compliance, this clamp should be installed on the TRANSMIT side of each SymLink cable.



**WARNING:** The RJ-45 connectors labeled “SYMLINK” are only for use with other SymLink products. DO NOT plug the SymLink connectors on Symetrix products into any RJ-45 connector labeled “ARC”, “ETHERNET” or “COBRANET. The “ARC” RJ-45 connectors on Symetrix products can carry anywhere from 6 to 24 VDC which can severely damage SymLink circuitry.

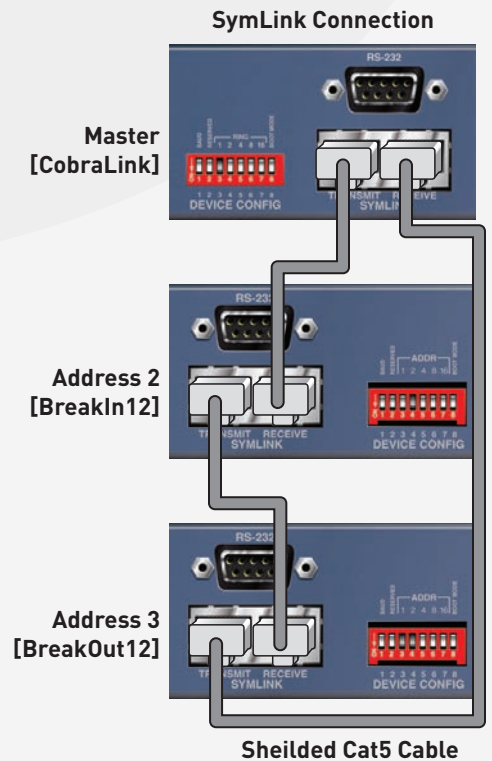

Device Addressing

Device Addressing

Every SymNet hardware device must be uniquely identified within its ring. A device address of 2 through 16 is available. (BreakIn12 and BreakOut12 units can not be SymLink Master units, so an address of 1 is not valid.) The device addresses of the physical hardware in your system must match the devices as configured in your SymNet Designer Site File. You may use the pictorial diagrams below to quickly set up and understand the device address DIP switches on the BreakIn12 or BreakOut12.

**Note:** Any time the DIP switches are changed, the unit(s) must be power cycled for the changes to take effect.

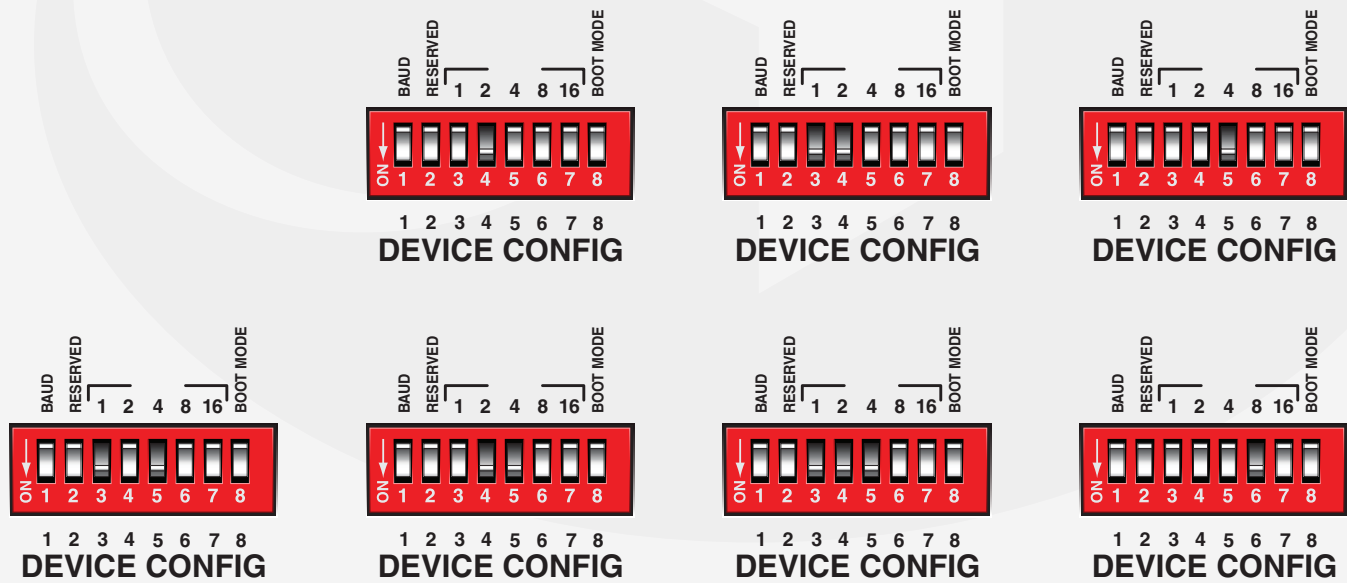

## SymNet Designer Software

### Installation

The SymNet Designer software provides real-time control over multiple audio functions from a Windows 98/2000/XP PC environment.

Use one of the following procedures to install the SymNet Designer on your computer.

From the SymNet Designer CD-ROM:

1. Insert the CD-ROM into your computer's CD-ROM drive.
2. If the software does not auto run, Click on the Start button, Run D:\SETUP

(If your CD-ROM drive isn't D:, then substitute its drive letter)

From the Symetrix web site (<http://www.SymetrixAudio.com>):

1. Download the SymNet Designer self-extracting installer.
2. Find the file you downloaded and double-click it to start the Setup program.

The software always starts up in offline mode. Regardless, you can explore the software, experiment to your heart's content, and perhaps even get useful work done. You can save any Sites that you create to a file that can be downloaded later into an operating SymNet system.

If there is a SymNet hardware device connected, you can download to, and upload from the SymNet system. Once you have a device connected, you can also work online in real time, which allows you to hear adjustments and settings as you make them.

### Using SymNet Designer

Once the installation process is complete, you should have an icon on your desktop, and a program item in the Start menu. Click on the SymNet Designer icon and you're ready to begin.

SymNet Designer is mostly self-explanatory. The Configuration Screen represents all SymNet hardware devices in a system. Each device can store up to 1000 presets. Using the tool kit (left-hand) window, you select the SymNet device that you wish to configure and drag it to the

configuration page. Double-clicking on the device opens it, and causes the tool kit to display all the different signal processors available. The tool kit window is context sensitive. It always displays the items that can be placed in the current window. You can use the Browser to navigate to all of the relevant windows opened.

Drag and drop signal processors into the configuration page. Connect them together by clicking on a connection point and moving the mouse in the direction you want the wire to run. Make corners by clicking at the corner and moving off in a new direction. Terminate a wire by clicking on the terminating connection point or by hitting the ESC key or right mouse button. Right click on an existing wire and choose "Start Wire" to make a tee connection.

Once you've completed your design, download it to the SymNet system. Double click on processors on the configuration page to see their DSP modules and routing. Double-click on a DSP module to change its settings.

**Note:** Many useful functions are available in the mouse right-click. Explore! That's the ultra-condensed version. You'll find more complete information in SymNet Designer's online help.

### Hardware Memory

SymNet saves its settings in internal flash memory, allowing it to recall settings through a power-down/up cycle. Unlike static RAM, the flash memory does not require batteries, and is designed to retain its memory for the life of the product.

**Declaration of Conformity**

We, Symetrix, Incorporated, 6408 216th St. SW, Mountlake Terrace, WA, 98043, USA, declare under our sole responsibility that the products:

- **SymNet™ BreakIn12**
- **SymNet™ BreakOut12**

...to which this declaration relates, are in conformity with the following standards:

**EN 55103-1**

Product family standard for audio, video, audio-visual and entertainment lighting control apparatus for professional use.

**Part 1: Emission.**

**EN 55103-2**

Product family standard for audio, video, audio-visual and entertainment lighting control apparatus for professional use.

**Part 2: Immunity.**

**EN 60065**

Safety requirements for mains operated electronic and related apparatus for household and similar general use.

The technical construction file is maintained at:  
Symetrix, Inc.

6408 216th St. SW  
Mountlake Terrace, WA, 98043  
USA

The authorized representative located within the European Community is:

World Marketing Associates  
P.O. Box 100  
St. Austell, Cornwall, PL26 6YU, England

Date of issue: 15 March, 2002

Place of issue: Mountlake Terrace, Washington, USA

Authorized signature:



**Dane Butcher, President, Symetrix Inc.**

## SymNet Family DIP Switch Settings

As of SymNet Designer software version 2.0, a maximum of 32 Rings, each having 16 Addresses, are possible. For the sake of space, only switch settings for the first 8 Rings or Addresses are pictured.

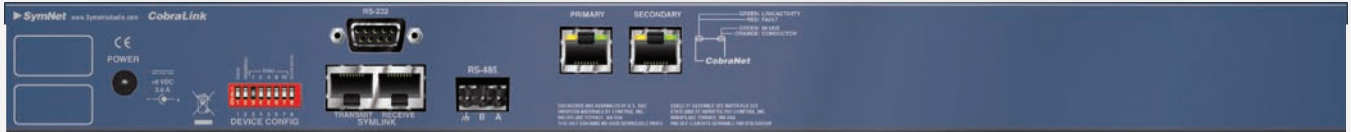

### SymNet CobraLink

**NOTE:** The DIP switches on a CobraLink device configure its **Ring number**. A CobraLink device is always at Address 1 and is the Master of its ring.

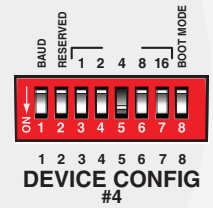
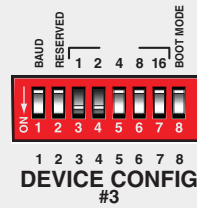
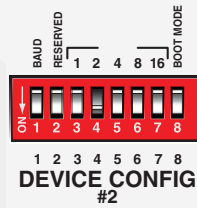
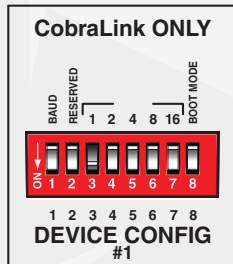

### SymNet BreakIn12 and BreakOut12

**NOTE:** On the Break I/Os, switches configure **address**. An Address of 1 is not valid on the BreakIn12 or Break-Out12 since these devices can not be the Master on a Ring.

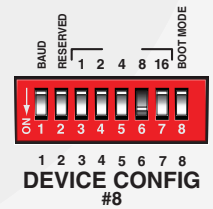
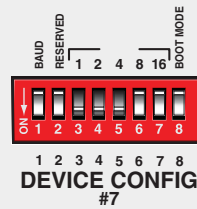
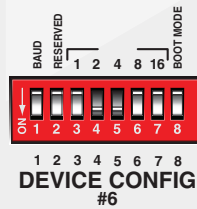
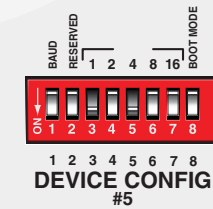

### SymNet 8x8 DSP

**NOTE:** Only one Master is allowed on the Ring and it should be Address 1.

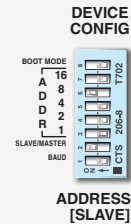
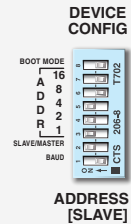
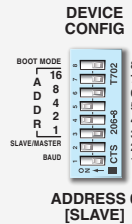
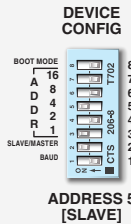
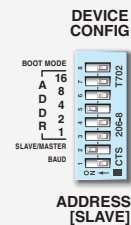
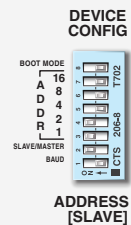
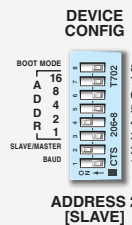
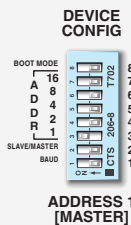

Cable Wiring Guide

### Balanced Connections

Any of these connectors can appear on either side of a balanced connection.

NOTE: In the case of an XLR connector, the Female attaches to an output, while the Male attaches to an input.

#### Euroblock [balanced]

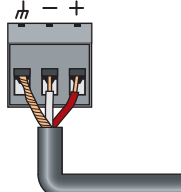

NOTE: Detachable Euroblock and Terminal Strip connectors are designed for use with bare wire. Do not tin stranded wires before inserting them into the connectors.

#### Terminal Strip [balanced]

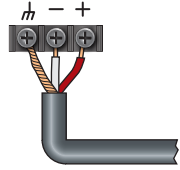

#### TRS 1/4" Plug [balanced]

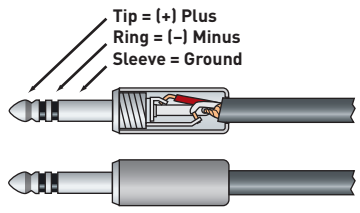

Tip = (+) Plus  
Ring = (-) Minus  
Sleeve = Ground

#### XLR Female Plug [balanced]

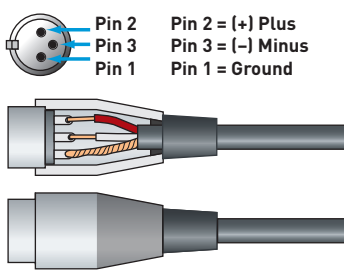

Pin 2 Pin 2 = (+) Plus  
Pin 3 Pin 3 = (-) Minus  
Pin 1 Pin 1 = Ground

#### XLR Male Plug [balanced]

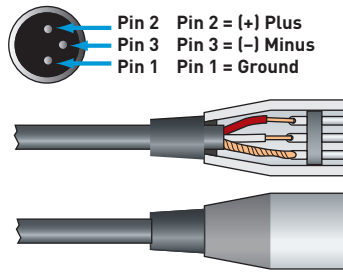

Pin 2 Pin 2 = (+) Plus  
Pin 3 Pin 3 = (-) Minus  
Pin 1 Pin 1 = Ground

Special Case: Female XLR connectors will ALWAYS be used coming from the OUTPUT of a device. Male connectors plug into the INPUT of a device.

### Unbalanced Connections

The RCA connector and the 1/4" TS connector are unbalanced connectors, wired with a single strand shielded wire and can be placed on either end of an unbalanced connection

#### TS 1/4" Plug [unbalanced]

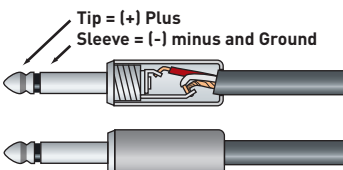

Tip = (+) Plus  
Sleeve = (-) minus and Ground

#### RCA Plug [unbalanced]

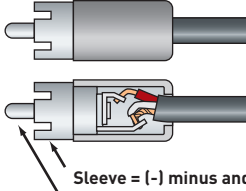

Sleeve = (-) minus and Ground  
Tip = (+) Plus

**! IMPORTANT NOTICE !**

The wiring diagrams on these pages are included **for information purposes only**.

Symetrix can not anticipate every connector type on non-Symetrix products. **It is the user's responsibility to determine what connection is needed.**

In addition, **Symetrix accepts no responsibility for injury or damage caused by user created wiring.**

### Unbalanced Connections: Unbalanced out to balanced in

The RCA connector and the 1/4" TS connector are unbalanced connectors. However, the wiring differs depending on if they are sending to, or receiving from a balanced connector.

In this example, the unbalanced connector is sending signal to a balanced connector. When wiring this connection, use a shielded twisted pair cable. The balanced side wires the same as a standard, balanced connection. On the unbalanced side, you wire the white (minus) wire together with the ground. This provides some common mode rejection at the balanced input.

#### TS 1/4" Plug [unbalanced out to balanced in]

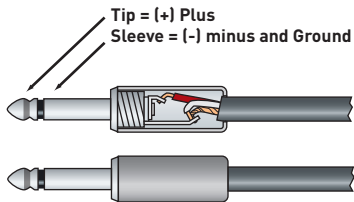

#### RCA Plug [unbalanced out to balanced in]

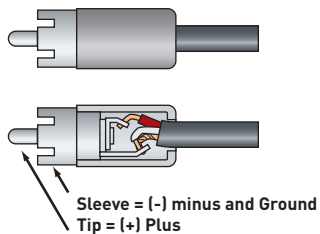

#### XLR Male Plug [balanced]

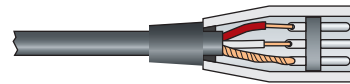

#### Euroblock [balanced]

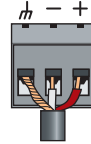

#### Terminal Strip [balanced]

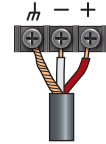

#### TRS 1/4" Plug [balanced]



### Unbalanced Connections: Balanced out to unbalanced in

When your output requires a balanced connector, but you are sending signal to an unbalanced input, the rules change. Use a single strand shielded wire. Wire only to the plus and ground terminals of what would be typically be the balanced connector.

#### XLR Female Plug [unbalanced]

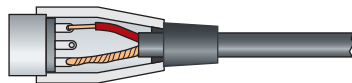
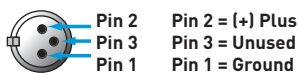

#### Euroblock [unbalanced] Terminal Strip [unbalanced]

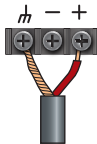
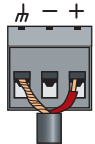

#### TRS 1/4" Plug [balanced]

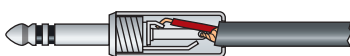

Tip = (+) Plus  
Ring = unused  
Sleeve = Ground

#### TS 1/4" Plug [balanced out to unbalanced in]

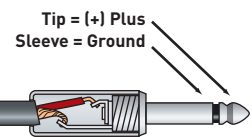

#### RCA Plug [balanced out to unbalanced in]

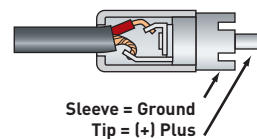

## Common Problems and Solutions

### Dancing Lights.

If any of your SymNet units power on and seem to suffer from Dancing Lights Syndrome, never fear. This simply means that there is no active Site File loaded. Download your Site File to the hardware (F4) in order for the settings to be stored.

### Serial Communications.

Be sure that you use a straight-through RS-232 cable connected to the DB9 port labeled RS-232. You must connect to whichever unit is master for a given ring. It is permissible to connect to any ring provided that you connect to the master unit (the unit with an Address of 1). By default, SymNet Designer communicates with the hardware units at a baud rate of 115,200 bps. This is how the baud DIP switch (number 1) is configured in the examples on page 9. However, if you have a PC that is incapable of operating at this speed, a setting of 57,600 bps is available. DIP switch 1 will be opposite of the examples on page 9 and the speed of 57,600 bps must be selected in SymNet Designer's Preferences dialog accessible from the File menu.

### SymLink Communications.

The SymLink bus uses industry standard CAT5 shielded Ethernet cable. The SymNet units are interconnected in a ring network fashion. The TRANSMIT of the first unit is connected to the RECEIVE of the second unit and so on. The last unit in the chain should then have its TRANSMIT connected to the first units RECEIVE to complete the ring. All SYMLINK ACTIVE green LEDs should be lit on the front of each SymNet device.

### Example:

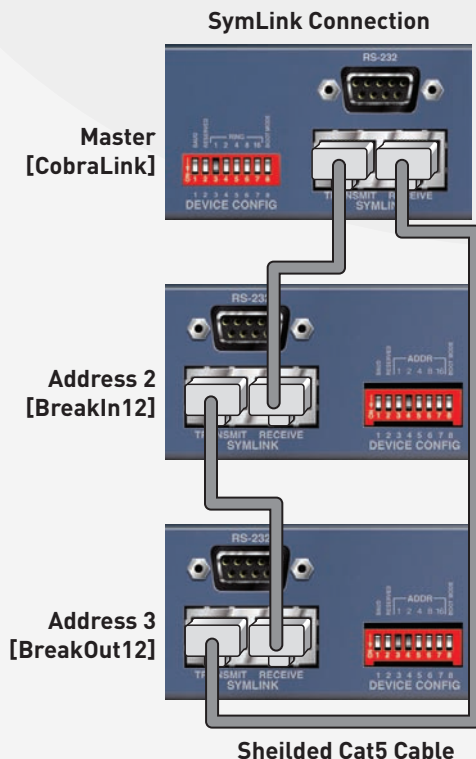

### Firmware.

**IMPORTANT:** To run SymNet Designer, the firmware in your hardware devices must match the firmware versions included with the software. If you receive SymNet Designer with a new SymNet device from the factory, then the firmware versions should already match. However, if you are connecting to an older SymNet system, the firmware versions in hardware must match those included with the version of SymNet Designer you are using. The correct firmware files are always included with each software release.

When downloading a Site File to SymNet hardware, the firmware versions will be checked and you will be prompted to upgrade firmware if necessary.

**CobraLink and Express Only:** For CobraLink and Express Cobra units, there is also CobraNet firmware from Cirrus Logic. You may need to upgrade this firmware as well. See Upgrading CobraNet Firmware using CobraNet Discovery in the SymNet Designer release notes for instructions.

### Upgrading Firmware using Auto Upgrade

1. Install SymNet Designer. This will copy the necessary firmware files to your computer.
2. Launch SymNet Designer.
3. Connect your hardware devices as they would be for normal operation. It is highly recommended to power down or disconnect power amplifiers and speakers.
4. In SymNet Designer, choose Hardware->Upgrade Firmware.
5. Press the Auto Upgrade button. This will upgrade all connected devices.
6. When finished, click 'Close'.

If you encounter problems with this procedure, use the Manual Upgrade procedure below.

### Upgrading Firmware - Manual Upgrade

1. Install SymNet Designer. This will copy the necessary firmware files to your computer.
2. Launch SymNet Designer.
3. Connect your hardware devices as they would be for normal operation. It is highly recommended to power down or disconnect power amplifiers and speakers.
4. In SymNet Designer, choose Hardware->Upgrade Firmware.
5. Click the 'Upgrade' button under SymNet Microprocessor file. An 'open' file dialog will appear allowing navigation to the firmware files. The default location is: C:\Program Files\Symetrix\SymNet Designer X.X\Upgrade.
6. Select the file SymNet\_MicroProc\_VXXXX.bin and click 'Open'.
7. When finished, click the 'Upgrade' button under SymNet FPGA file. Select the SymNet\_FPGA\_VXXXX.bit file and click 'Open'.
8. If you have more than one SymNet device, select each device using the Address dropdown at the top of the dialog box and repeat steps 4-6.
9. If you are using CobraLink or Express Cobra and have more than one ring, repeat for all devices on all rings using the Ring dropdown at the top of the dialog box.
10. When finished, click 'Close'.

## The Symetrix Limited Warranty

Symetrix, Inc. expressly warrants that the product will be free from defects in material and workmanship for eighteen (18) months from the date the product is shipped from the factory. Symetrix's obligations under this warranty will be limited to repairing or replacing, at Symetrix's option, the part or parts of the product which prove defective in material or workmanship within eighteen (18) months from the date the product is shipped from the factory, provided that the Buyer gives Symetrix prompt notice of any defect or failure and satisfactory proof thereof. Products may be returned by Buyer only after a Return Authorization number (RA) has been obtained from Symetrix. Buyer will prepay all freight charges to return the product to the Symetrix factory. Symetrix reserves the right to inspect any products which may be the subject of any warranty claim before repair or replacement is carried out. Symetrix may, at its option, require proof of the original date of purchase (dated copy of original retail dealer's invoice). Final determination of warranty coverage lies solely with Symetrix. Products repaired under warranty will be returned freight prepaid via United Parcel Service by Symetrix, to any location within the Continental United States. Outside the Continental United States, products will be returned freight collect.

**The foregoing warranties are in lieu of all other warranties, whether oral, written, express, implied or statutory. Symetrix, Inc. expressly disclaims any IMPLIED warranties, including fitness for a particular purpose or merchantability. Symetrix's warranty obligation and buyer's remedies hereunder are SOLELY and exclusively as stated herein.**

This Symetrix product is designed and manufactured for use in professional and studio audio systems and is not intended for other usage. With respect to products purchased by consumers for personal, family, or household use, Symetrix expressly disclaims all implied warranties, including but not limited to warranties of merchantability and fitness for a particular purpose.

This limited warranty, with all terms, conditions and disclaimers set forth herein, shall extend to the original purchaser and anyone who purchases the product within the specified warranty period.

Symetrix does not authorize any third party, including any dealer or sales representative, to assume any liability or make any additional warranties or representation regarding this product information on behalf of Symetrix.

This limited warranty gives the buyer certain rights. You may have additional rights provided by applicable law.

**Note:** Some Symetrix products contain embedded software and may also be accompanied by control software intended to be run on a personal computer. Said software is specifically excluded from this warranty.

## Limitation of Liability

The total liability of Symetrix on any claim, whether in contract, tort (including negligence) or otherwise arising out of, connected with, or resulting from the manufacture, sale, delivery, resale, repair, replacement or use of any product will not exceed the price allocatable to the product or any part thereof which gives rise to the claim. In no event will Symetrix be liable for any incidental or consequential damages

including but not limited to damage for loss of revenue, cost of capital, claims of customers for service interruptions or failure to supply, and costs and expenses incurred in connection with labor, overhead, transportation, installation or removal of products, substitute facilities or supply houses.

## Servicing Your Symetrix Product

If you have determined that your Symetrix product requires repair services and you live outside of the United States please contact your local Symetrix dealer or distributor for instructions on how to obtain service. If you reside in the U.S. then proceed as follows.

## Return authorization

At the Symetrix factory, Symetrix will perform in-warranty or out-of-warranty service on any product it has manufactured for a period of three (3) years from date of discontinued manufacture.

Before sending anything to Symetrix, please contact our Customer Service Department for a return authorization (RA) number. The telephone number is +1 (425) 778-7728. Additionally support is available via the web site: <http://www.SymetrixAudio.com>.

## In-warranty repairs

To get your Symetrix product repaired under the terms of the warranty:

1. Call us for an RA number (have the serial number, shipping and contact information and description of the problem ready).
2. Pack the unit in its original packaging materials.
3. Include your name, address, daytime telephone number, and a brief statement of the problem.
4. Write the RA number on the **outside** of the box.
5. Ship the unit to Symetrix, freight prepaid. We do not accept freight collect shipments.

Just do these five things, and repairs made in-warranty will cost you only one way freight charges. We'll pay the return freight.

If you don't have the factory packaging materials, we recommend using an oversize box. Wrap the unit in a plastic bag, surround it with bubble-wrap, and place it in the box surrounded by Styrofoam peanuts. Be sure there is enough clearance in the box to protect the rack ears. We won't return the unit in anything but Symetrix packaging for which we will have to charge you. If the problem is due to operator misuse or error, you will have to pay for both parts and labor. In any event, if there are charges for the repair, you will pay for the return freight. All charges will be COD unless you have made other arrangements (prepaid, Visa or Mastercard).

## Out-of-warranty repairs

If the warranty period has passed, you'll be billed for all necessary parts, labor, packaging materials, and freight charges. Please remember, you must call for an RA number before sending the unit to Symetrix.

# **SymNet™** | Network Audio Solutions

6408 216th St. SW | Mountlake Terrace, WA 98043 | USA | Tel: +1 (425) 778.7728 | Fax: +1 (425) 778.7727

## Engineered by **Symetrix™**

### **SymNet BreakIn12/BreakOut12 Quick Start Guide**

© 2008 Symetrix, Inc. All rights reserved. Printed in the United States of America. The information in this document is subject to change without notice. Symetrix, Inc. shall not be liable for technical or editorial errors or omissions contained herein; nor is it liable for incidental or consequential damages resulting from the furnishing, performance, or use of this material. Mention of third-party products is for informational purposes only and constitutes neither an endorsement nor a recommendation. Symetrix assumes no responsibility with regard to the performance or use of these products. Under copyright laws, no part of this brochure may be reproduced or transmitted in any form or by any means, electronic or mechanical, without permission in writing from Symetrix, Inc. If, however, your only means of access is electronic, permission to print one copy is hereby granted. The following are either Trademarks or Registered Trademarks of Symetrix, Inc.: Symetrix, SymNet, SymNet Designer, SymLink and CobraLink. Windows is a Registered Trademark of Microsoft, Inc.. Other product names mentioned herein may be trademarks and/or registered trademarks of other companies and are property of their respective owners.